

Legenda - Description	Struttura	Structure	Struktur	Structure
<p>1 Meccanismo in acciaio, reclinabile, con cinghie elastiche da mm.30 Articulated steel adjustment, with elastic belts 30 mm. Verstellbares Stahlmechanismus, mit elastische Gurte 30 mm. Mécanisme en acier, réglable avec sangles élastiques de 30 mm.</p> <p>2 Struttura in acciaio Steel frame Stahlstruktur Structure en acier</p> <p>3 5 - 6: Poliuretani a densità e portanza differenziate 5 - 6: Polyurethane foam in varied densities 5 - 6: Polyurethanschaum in untersch. Raumdichtigkeiten 5 - 6: Mousse polyuréth. à densités différenciées</p> <p>4 Schiuma poliuretanic flessibile con densità 60 Kg/mc. Flexible polyurethane foam density 60 Kg/mc. Flexibler Polyurethanschaum, Dichtigkeit 60 Kg/mc. Mousse en polyuréthane flexible à densité 60 Kg/mc.</p> <p>7 Piede in polipropilene Polypropylene feet Polypropylenfuss Pied en polypropylène</p> <p>8 Struttura in legno Hardwood frame Holzstruktur Structure en bois</p>	<p>Sedile in legno rivestito con poliuretano espanso indeformabile a densità differenziate e fibra poliester. Schienale e bracciolo in espanso schiumato a freddo ignifugo con struttura e meccanismo d'inclinazione in acciaio, rivestiti in fibra poliester.</p> <p>I piani dei tavolini sono in lamiera inox ornamentale elettrocolorata. Si consiglia per il tavolino 50x50 (cod.0AL) e il tavolino basso 100x100 (cod. 0CY) il rivestimento in pelle.</p> <p><b>Piedi</b> I piedi, avvitati alla struttura, sono in polipropilene nero. Gli elementi vengono uniti tra di loro tramite un dispositivo d'aggancio in ABS color nero.</p> <p><b>Sovraprezzi</b> Maggiorazione per traversa centrale optional per letti 300 €.</p> <p><b>Caratteristiche</b> La collezione HIGHLANDS è completamente sfoderabile eccetto i tavolini (cod. 0AL e 0CY), non verrà prodotta con tessuti fiorati, rigati o con verso.</p> <p>I letti (cod.175 - 176 - 177) vengono consegnati smontati.</p> <p><b>NON SI ACCETTANO ORDINI DI ELEMENTI FUORI MISURA.</b></p>	<p>Seat is stress-resistant polyurethane foam in varied densities and polyester fiberfill on hardwood frame. Back and armrests are injected cold flame-retardant polyurethane foam and polyester fiberfill over internal steel frame with articulating mechanism.</p> <p>Table tops are in DECO electrochemically stained stainless steel plate . Leather cover is recommended for table 50x50 (code OAL) and low table 100x100 (code OCY).</p> <p><b>Feet</b> Black polypropylene feet, screwed to the frame. Elements can be linked together with black ABS joining device.</p> <p><b>Surcharge</b> Upcharge for center beam on beds 300 €.</p> <p><b>Spec. Characteristics</b> HIGHLANDS seating covers are removable. Coffee table (codes 0AL - OCY) upholstery is fixed and not available in fabrics with pattern repeats.</p> <p>Beds (cod.175 - 176 - 177) are delivered unassembled.</p> <p>REQUESTS FOR CUSTOM VERSIONS CANNOT BE ACCEPTED.</p>	<p>Sitz aus Holz, mit unverformbarem Polyurethanschaum in unterschiedlichen Raumgewichte gepolstert und mit Polyesterwatte umhüllt. Ruecken und Armlehnen aus Stahl kaltgeschäummt in feuerhemmendem und Polyesterwatte mit endlos verstellbaren Mechanismus. Tischoberfläche aus DECO Edelstahlblech elektrochemisch gefärbt. Für das Tischchen 50x50 cm (Cod. OAL) und das niedrige Tischchen 100x100 (Cod.OCY) wird ein Lederbezug empfohlen.</p> <p><b>Füsse</b> Fuesse aus polypropylen schwarz mit schraube fixiert. Die Elemente koennen an den Fuessen durch Verbindungselemente fixiert werden.</p> <p><b>Aufpreis</b> Aufpreis fuer Mittelstrebe fue Betten 300 €.</p> <p><b>Besonderheiten</b> Kollektion HIGHLANDS ist komplett abziehbar, aussert Beistelltische (Kodes 0AL - 0CY) und kann nicht mit gemusterten- oder gestreiften Stoffen hergestellt werden.</p> <p>Die Betten (Kod.175 - 176 - 177) werden zerlegt ausgeliefert.</p> <p>SONDERANFERTIGUNGE N KOENNEN NICHTAUSGEFUEHRT WERDEN.</p>	<p>Assise en bois recouverte de mousse polyuréthane indéformable à densités différenciées et ouatte syntétique. Dossier et accoudoires en acier enrobée dans la mousse ignifugée injectée a froid et ouatte synthétique avec mécanisme réglable.</p> <p>Le plateau des tables sont en acier inox DECO avec traitement couleur electrochimique. Le revêtement en cuir est conseillé pour la petite table 50x50 (code OAL) et pour la table basse 100x100 (code OCY).</p> <p><b>Pieds</b> Les pieds vissés à la structure sont en polypropylène noir. Les éléments peuvent être unis entre eux par un dispositif d'union en ABS couleur noir.</p> <p><b>Suppl. de prix</b> Surcharge de 300 € traverse central pour lits.</p> <p><b>Caractéristiques</b> La collection HIGHLANDS est complètement déhoussable sauf le tables basse (codes 0AL - 0CY) et n'est pas disponible en tissus avec dessins et rayures.</p> <p>Les lits (cod.175 -176 - 177) sont livrés démontés.</p> <p>DES COMMANDES HORS MESURE NE SONT PAS ACCEPTEES.</p>

**Fodera**  
Ersatzbez

Cover  
Housse

m **Tessuto**  
Stoff

Fabric  
Tissu

m<sup>2</sup> **Pelle**  
Leder

Leather  
Cuir

Kg **P. lordo**  
Bruttogew.

Gr. Weight  
Poids Brut

m<sup>3</sup> **Volume**  
Volumen

Volume  
Volume

**Cod. 018**

**Divano 2 posti major 240**

2 seater sofa major 240

Sofa 2-Sitzig Major 240

Canapé 2 places major 240

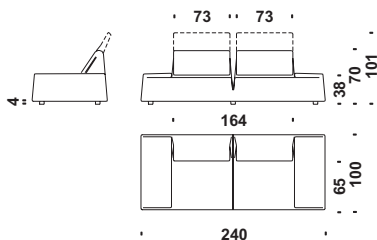

m 11

m<sup>2</sup> 21

Kg 98

m<sup>3</sup> 2

**Cod. 003**

**Divano 3 posti 275**

3 seater sofa 275

Sofa 3-Sitzig 275

Canapé 3 places 275

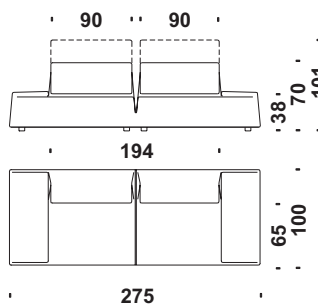

m 12,1

m<sup>2</sup> 23,1

Kg 105

m<sup>3</sup> 2,2

**Cod. 035**

**Divano 3p smontato 275**

3 seater sofa knocked down 275

Sofa 3-Sitzig abmontiert 275

Canapé 3 places démonté 275

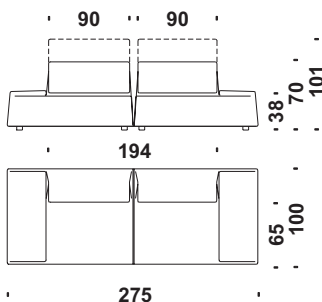

m 12,1

m<sup>2</sup> 23,1

Kg 108

m<sup>3</sup> 2,2

**Cod. 06C**

**Elemento 1p centrale 83**

Central element 83

Zentralelement 83

Élément central 83

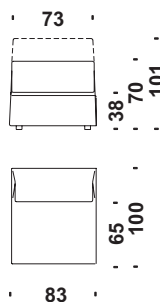

m 4,8

m<sup>2</sup> 8,1

Kg 33

m<sup>3</sup> 0,65

**Cod. 011**

**Elemento 1p centrale 100**

Central element 100

Zentralelement 100

Élément central 100

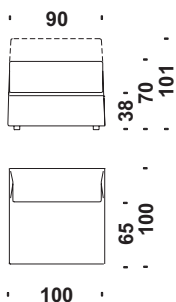

m 4,8

m<sup>2</sup> 9,2

Kg 36

m<sup>3</sup> 0,8

**Cod. 142**

**Elem.1p destro senza bracc.120**

1 seat. elem. right without armrest 120

Elem. 1-sitzig rechts Ohne Arml. 120

El. 1 places droit sans accoud. 120

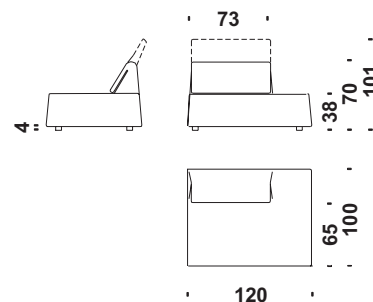



m 4,5

m<sup>2</sup> 8,6

Kg 43

m<sup>3</sup> 1

 **Fodera**  
Ersatzbez Cover  
Housse

 m **Tessuto**  
Stoff Fabric  
Tissu

 m<sup>2</sup> **Pelle**  
Leder Leather  
Cuir

 Kg **P. lordo**  
Bruttogew. Gr. Weight  
Poids Brut

 m<sup>3</sup> **Volume**  
Volumen Volume  
Volume

**Cod. 143 Elem.1p sinistro senza bracc.120**

1 seat. elem. left without armrest 120  
Elem. 1-sitzig links Ohne Arml. 120  
El. 1 places gauche sans accoud. 120

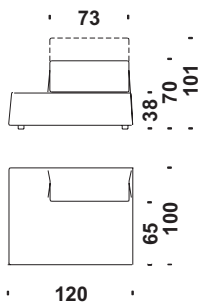

120

 m 4,5  m<sup>2</sup> 8,6  Kg 43  m<sup>3</sup> 1

**Cod. 140 Elem.1p destro senza bracc.137**

1 seat. elem. right without armrest 137  
Elem. 1-sitzig rechts Ohne Arml. 137  
El. 1 places droit sans accoud. 137

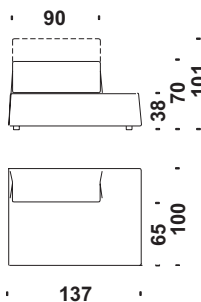

137

 m 5  m<sup>2</sup> 9,5  Kg 46  m<sup>3</sup> 1,1

**Cod. 141 Elem.1p sinistro senza bracc.137**

1 seat. elem. left without armrest 137  
Elem. 1-sitzig links Ohne Arml. 137  
El. 1 places gauche sans accoud. 137

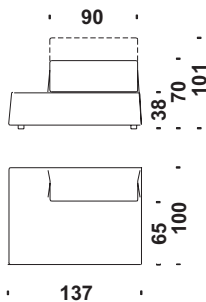

137

 m 5  m<sup>2</sup> 9,5  Kg 46  m<sup>3</sup> 1,1

**Cod. 06D Elemento 1p bracciolo destro 120**

1 seater element armrest right 120  
Element 1-sitzig Armlehne rechts 120  
El. 1 places accoudoir droit 120

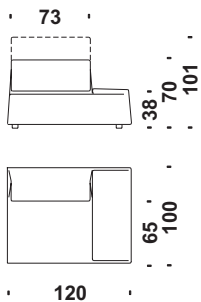

120

 m 5,5  m<sup>2</sup> 10,5  Kg 51  m<sup>3</sup> 1

**Cod. 06E Elemento 1p bracciolo sinistro 120**

1 seater element armrest left 120  
Element 1-sitzig Armlehne links 120  
El. 1 places accoudoir gauche 120

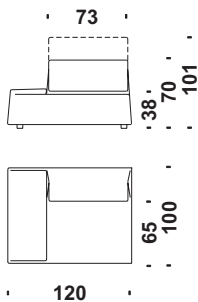

120

 m 5,5  m<sup>2</sup> 10,5  Kg 51  m<sup>3</sup> 1

**Cod. 012 Elemento 1p bracciolo destro 137**

1 seater element armrest right 137  
Element 1-sitzig Armlehne rechts 137  
El. 1 places accoudoir droit 137

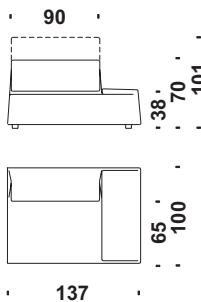

137

 m 6  m<sup>2</sup> 11,5  Kg 54  m<sup>3</sup> 1,1

Fodera  
Ersatzbez

Cover  
Housse

m Tessuto  
Stoff

Fabric  
Tissu

m<sup>2</sup> Pelle  
Leder

Leather  
Cuir

Kg P. lordo  
Bruttogew.

Gr. Weight  
Poids Brut

m<sup>3</sup> Volume  
Volumen

Volume  
Volume

**Cod. 013** **Elemento 1p bracciolo sinistro 137**

1 seater element armrest left 137  
Element 1-sitzig Armlehne links 137  
El. 1 places accoudoir gauche 137

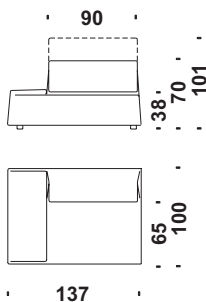

m 6 m<sup>2</sup> 11,5 Kg 54 m<sup>3</sup> 1,1

**Cod. 034** **Chaise Longue centrale 83**

Chaise Longue central 83  
Chaise Longue zentral 83  
Chaise Longue central 83

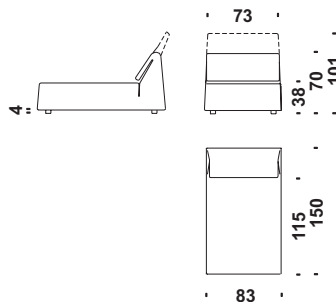

m 5,4 m<sup>2</sup> 10,3 Kg 43 m<sup>3</sup> 1,15

**Cod. 04S** **Chaise Longue centrale 100**

Chaise Longue central 100  
Chaise Longue zentral 100  
Chaise Longue central 100

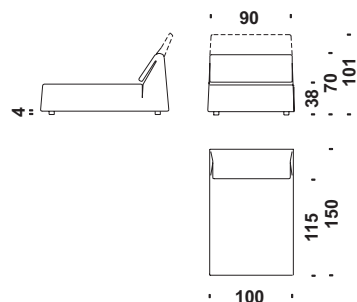

m 5,5 m<sup>2</sup> 11,8 Kg 46 m<sup>3</sup> 1,2

**Cod. 0D3** **Chaise Longue destra senza br.120**

Chaise Longue right without armr. 120  
Chaise Longue rechts Ohne Arml. 120  
Chaise Longue droit sans acc. 120

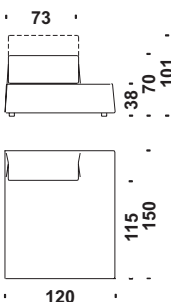

m 5,9 m<sup>2</sup> 12,3 Kg 58 m<sup>3</sup> 1,6

**Cod. 0D4** **Chaise Longue sinistra senza br.120**

Chaise Longue left without armr. 120  
Chaise Longue links Ohne Arml. 120  
Chaise Longue gauche sans acc. 120

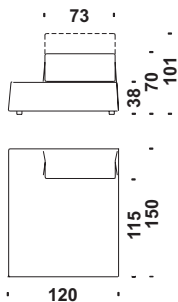

m 5,9 m<sup>2</sup> 12,3 Kg 58 m<sup>3</sup> 1,6

**Cod. 06V** **Chaise Longue bracc.destro 120**

Chaise Longue armrest right 120  
Chaise Longue Armlehne rechts 120  
Chaise Longue accoudoir droit 120

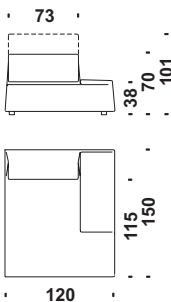

m 6,6 m<sup>2</sup> 14,4 Kg 66 m<sup>3</sup> 1,6

**Fodera** Cover **Tessuto** Fabric **Pelle** Leather **P. lordo** Gr. Weight **Volume** Volume  
 Ersatzbez Housse Stoff Tissu Leder Cuir Bruttogew. Poids Brut Volumen Volumen

**Cod. 06W Chaise Longue bracc.sinistro 120**

Chaise Longue armrest left 120  
 Chaise Longue Armlehne links 120  
 Chaise Longue accoudoir gauche 120

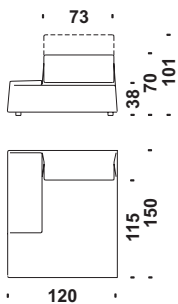

m 6,6 m² 14,4 Kg 66 m³ 1,6

**Cod. 152 Highlands pouf 50x50**

Highlands stool 50x50  
 Highlands Hocker 50x50  
 Highlands pouf 50x50

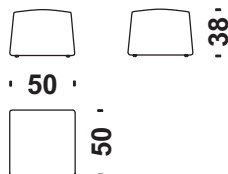

m 1,5 m² 1,8 Kg 11 m³ 0,16

**Cod. 154 Highlands pouf 100x83**

Highlands stool 100x83  
 Highlands Hocker 100x83  
 Highlands pouf 100x83

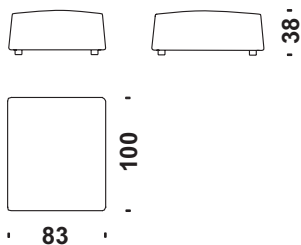

m 2,9 m² 3,5 Kg 22 m³ 0,35

**Cod. 153 Highlands pouf 100x100**

Highlands stool 100x100  
 Highlands Hocker 100x100  
 Highlands pouf 100x100

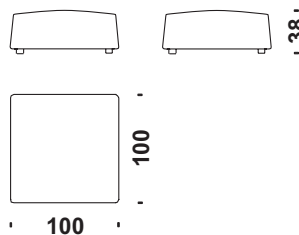

m 2,9 m² 3,5 Kg 24 m³ 0,45

**Cod. 0AL Tavolino 50x50**

Table 50x50  
 Tisch 50x50  
 Table 50x50

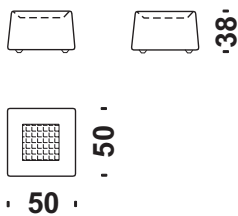



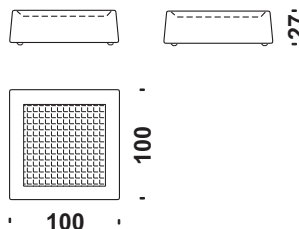

m 1,2 m² 1,5 Kg 13 m³ 0,16

**Cod. 0CY Tavolino basso 100x100**

Table low 100x100  
 Tisch tief 100x100  
 Table bas 100x100



m 2 m² 2,5 Kg 27 m³ 0,35

 **Fodera** Cover  
 Ersatzbez Housse  
 m **Tessuto** Fabric  
 Stoff Tissu  
 m<sup>2</sup> **Pelle** Leather  
 Leder Cuir  
 Kg **P. lordo** Gr. Weight  
 Bruttogew. Poids Brut  
 m<sup>3</sup> **Volume** Volume  
 Volumen Volume

**Cod. 175** **Letto 160**  
 Bed 160  
 Bett 160  
 Lit 160

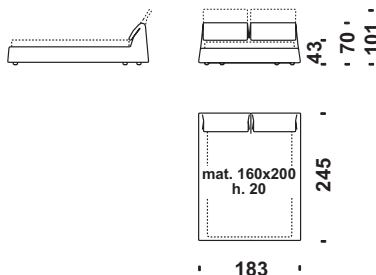

 m 8,2  
 m<sup>2</sup> 16,5  
 Kg 88  
 m<sup>3</sup> 1,5

**Cod. 176** **Letto 170**  
 Bed 170  
 Bett 170  
 Lit 170

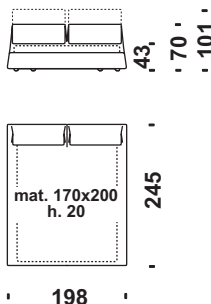

 m 9,1  
 m<sup>2</sup> 17,2  
 Kg 90  
 m<sup>3</sup> 1,5

**Cod. 177** **Letto 180**  
 Bed 180  
 Bett 180  
 Lit 180

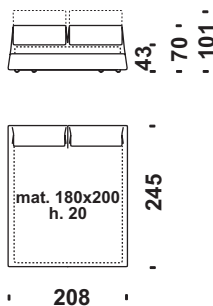

 m 9,2  
 m<sup>2</sup> 17,9  
 Kg 92  
 m<sup>3</sup> 1,5

**Cod. 195** **Rete doghe 200x160**  
 Slatted base 200x160  
 Lattenrost 200x160  
 Sommier à lattes 200x160

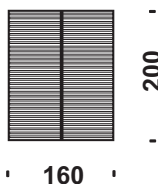

 m<sup>3</sup> 0,25

**Cod. 196** **Rete doghe 200x170**  
 Slatted base 200x170  
 Lattenrost 200x170  
 Sommier à lattes 200x170

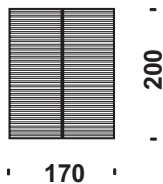

 m<sup>3</sup> 0,25

**Cod. 197** **Rete doghe 200x180**  
 Slatted base 200x180  
 Lattenrost 200x180  
 Sommier à lattes 200x180

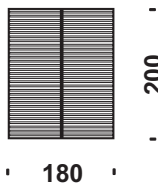

 m<sup>3</sup> 0,25

 **Fodera**  
Ersatzbez

Cover  
Housse

 m **Tessuto**  
Stoff

Fabric  
Tissu

 m<sup>2</sup> **Pelle**  
Leder

Leather  
Cuir

 Kg **P. lordo**  
Bruttogew.

Gr. Weight  
Poids Brut

 m<sup>3</sup> **Volume**  
Volumen

Volume  
Volume

**Composizione "A"**

Composition "A"  
Zusammenstellung "A"  
Composition "A"

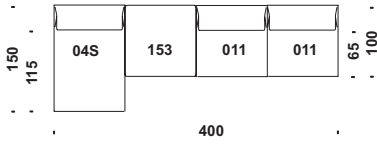

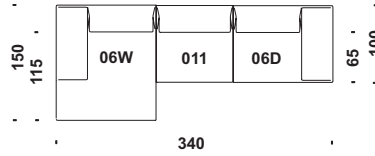

**Composizione "B"**

Composition "B"  
Zusammenstellung "B"  
Composition "B"





 m 18

 m<sup>2</sup> 33,7

 Kg 142

 m<sup>3</sup> 3,3

 m 16,9

 m<sup>2</sup> 34,1

 Kg 153

 m<sup>3</sup> 3,4